

▲ SHELF SYSTEMS

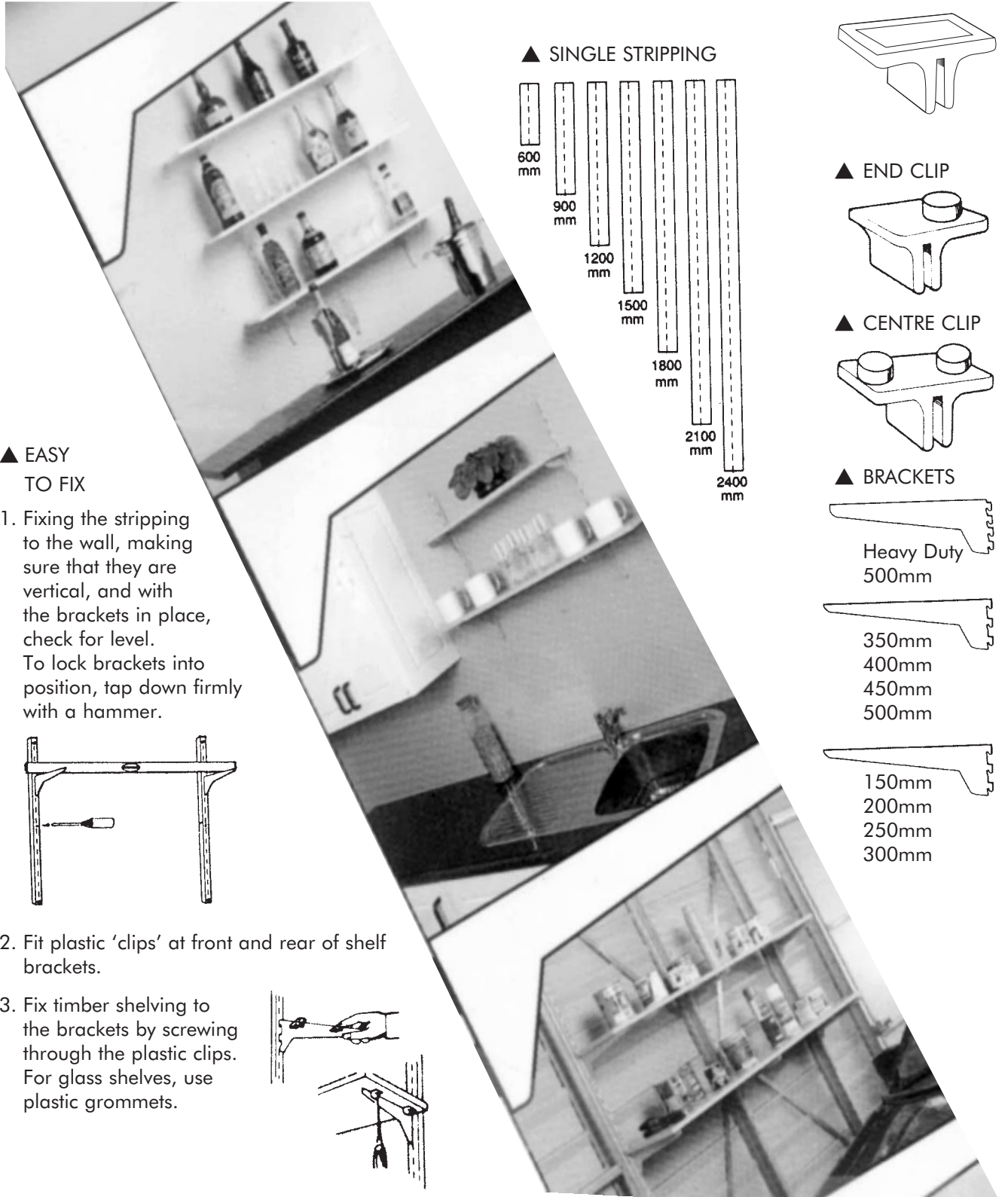

▲ EASY TO FIX

1. Fixing the stripping to the wall, making sure that they are vertical, and with the brackets in place, check for level. To lock brackets into position, tap down firmly with a hammer.

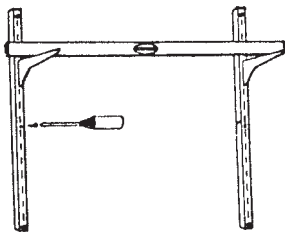

2. Fit plastic 'clips' at front and rear of shelf brackets.

3. Fix timber shelving to the brackets by screwing through the plastic clips. For glass shelves, use plastic grommets.

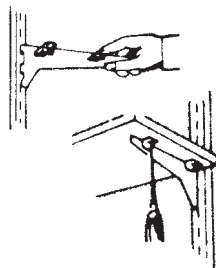

▲ SINGLE STRIPPING

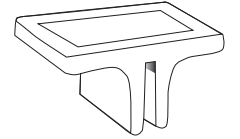
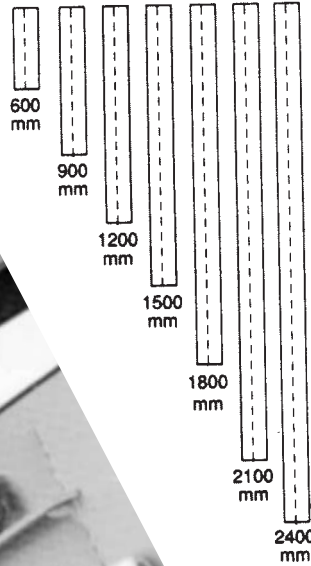

▲ END CLIP

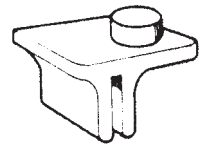

▲ CENTRE CLIP

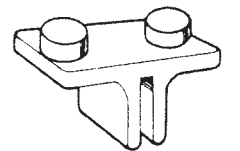

▲ BRACKETS

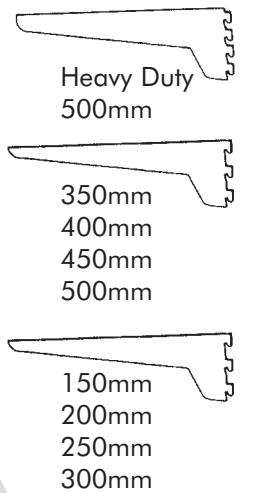

- ### ▲ DOUBLE SLOT STRIPPING
- Available in chrome, white or black

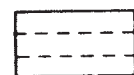

1,800mm
2,100mm
2,400mm

▲ TIMBER SHELVES

Length: 2,400mm

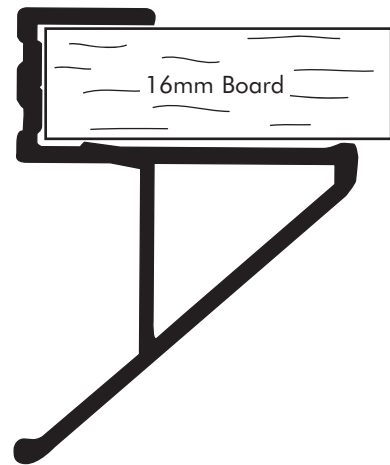

COLOUR	CODE
White	5535620
Matt Natural	5535618

▲ GLASS SHELVES

Length: 2,400mm

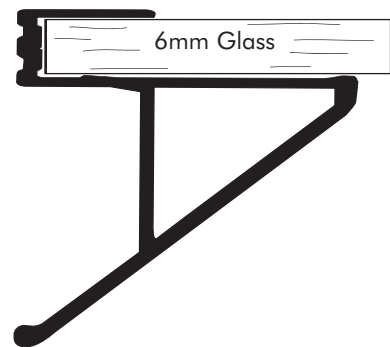

COLOUR	CODE
Matt Natural	5535660

GROOVED PANELS

▲ SHELVING SYSTEMS

▲ ALUMINIUM EXTRUSIONS

NOVER

▲ GROOVED PANELS



STOCK OPTIONS:

Large range of other decorator colours, timber veneers and acrylic mirror available to order.

CENTRES

75mm	100mm	150mm
White	White	White
Silver Grey	Silver Grey	Silver Grey
Raw MDF	Raw MDF	Raw MDF

Introducing a breakthrough development for grooved panels and slotted stripping...

▲ FLEXIBLE LIP EXTRUSION (FL)

FEATURES, BENEFITS AND INSTALLATION:

- ▲ Screw through the slot of the grooved panel with a countersink screw.
- ▲ Clip in extrusion from the front.
- ▲ Tests have shown this method to be 50% faster to install than slide-in extrusions, onsite or in the workshop.

Hidden fixings: It is impossible to hide screw fixings in cavity installations but not with the FL extrusion.

Hygienic: The flat lower lip prevents dirt build-up. The FL extrusion will also clip out for future changes.

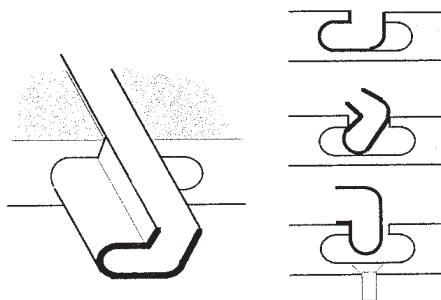

SIZE	COLOUR	CODE
2,400mm	White	190950
	Black	190960
	Grey	190970

▲ ALUMINIUM EXTRUSIONS – MILL FINISH

All extrusions are 2.4m in length

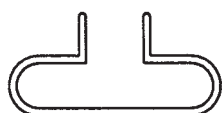

CODE
190900



CODE
190901

ORDERED ON REQUEST

▲ FLAT DISPLAY SHELF



SIZE	CODE
250 x 100mm	192210

▲ FLAT SHELF W/TICKET LIP



SIZE	CODE
250 x 100mm	192330

▲ SLOPING SHOE SHELF

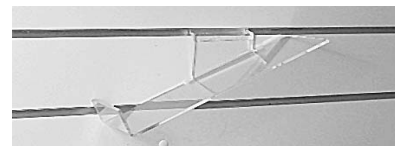

DESCRIPTION	CODE
LH Toe Stop	192130L
RH Toe Stop	192130R
LH Heel Stop	192135L
LH Heel Stop	192135R

▲ SWIVEL SHOE SHELF

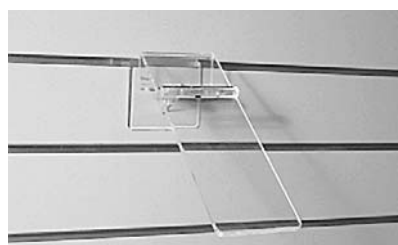

SIZE	CODE
260 x 90mm	192110

▲ DISPLAY BIN



SIZE	CODE
240 x 200 x 150mm	192510

▲ DISPLAY BIN



SIZE	CODE
240 x 200 x 150mm	192610

▲ BROCHURE HOLDER



SIZE	CODE
A4	192815

▲ VIDEO HOLDER

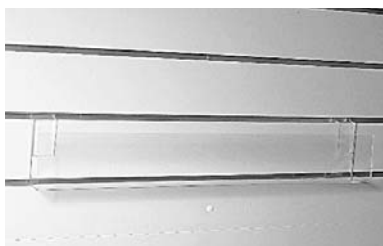

SIZE	CODE
600mm	192710

▲ SIGN HOLDER



SIZE	CODE
A4	192790

▲ SLOPING DISPLAY SHELF

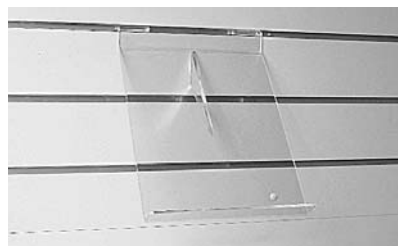

SIZE	CODE
270 x 220mm	192220

▲ FLAT DISPLAY SHELF

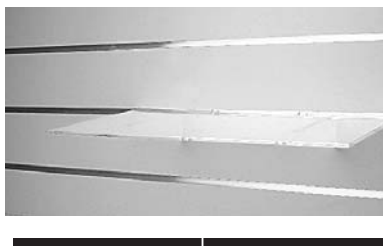

SIZE	CODE
400 x 200mm	192230
400 x 250mm	192231

▲ FLAT DISPLAY SHELF W/LIP



SIZE	CODE
500 x 150mm	192235
500 x 250mm	192237

▲ STRAIGHT BRACKET
 Finish: Chrome and White
 Sizes: 150, 200, 250, 300,
 350, 400, 450 & 500mm



▲ RING BRACKET
 Finish: Chrome
 Size: 300mm

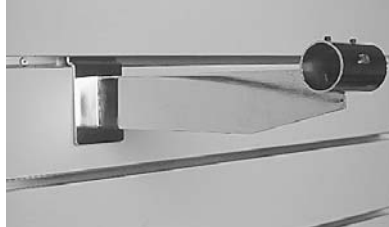

▲ DISPLAY PRONGS
 Finish: Chrome and White
 Sizes: 75, 100, 150, 200,
 230 & 300mm



▲ DOUBLE PRONGS
 Finish: Chrome
 Sizes: 100, 150, 200, 250
 & 300mm



▲ PEGBOARD HOOKS
 Finish: Chrome
 Sizes: 75, 150 & 230mm



▲ PICTURE HOOKS
 Finish: Chrome and White



▲ HATSTAND
 Finish: Chrome

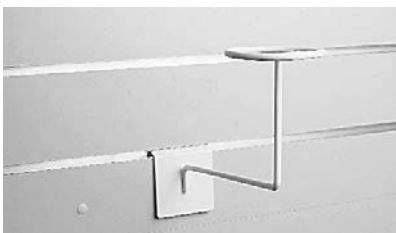

▲ BALL HOLDERS
 Finish: Chrome

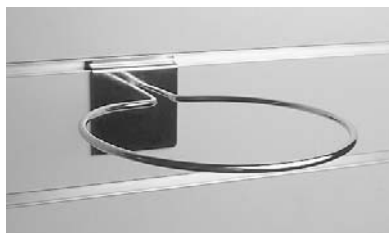

▲ STRAIGHT ARM
 Finish: Chrome
 Size: 300mm

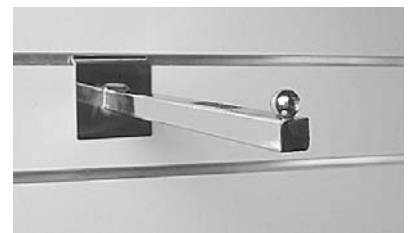

▲ HANDBAG ARM
 Finish: Chrome
 Size: 300mm



▲ SLOPING BLOUSE ARMS
 Finish: Chrome and White
 Sizes: 500mm

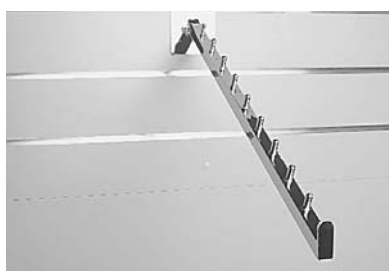

Talk to your

NOVER

Representative

▲ 18mm U-CHANNEL

18mm Board x 3.61 metres

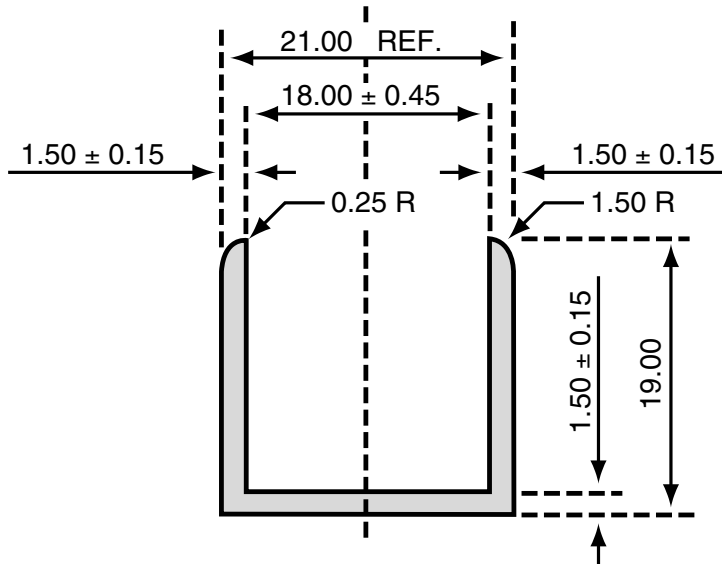

COLOUR	CODE
Mill Finish	888600
Clear Anodised	888601

▲ ANGLE

20 x 20 x 1.6mm x 6.5 metres

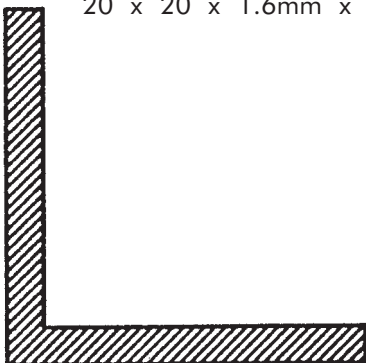

COLOUR	CODE
Mill Finish	888620
Clear Anodised	888621
White	888622

▲ FOLDING TABLE LEGS

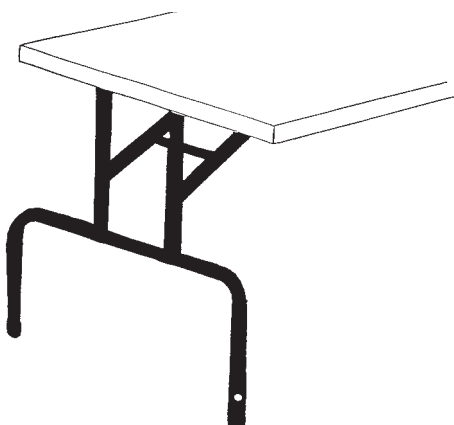

Black Enamelled
Tubular Steel

CODE
101250

▲ SERIES 777

SATIN STAINLESS STEEL

1 – Spring Hinge

Material:
304 Grade Stainless Steel
Finish:
Brush Satin



2 – Coat Hook

Material:
Diecast Zinc
Finish:
S.C.P.



3 – Turnbolt

Material:
Diecast Zinc
Finish:
Brush Satin



4 – Staple

Material:
Brass
Finish:
Brush Satin

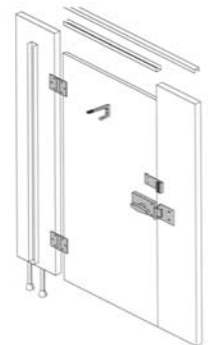
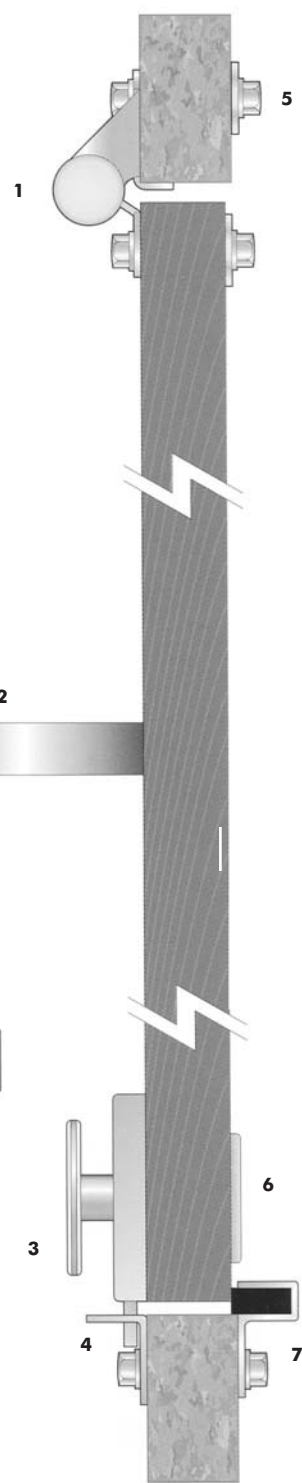
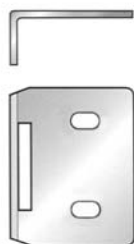

5 – Dress Plate

Material:
304 Grade SS
Finish:
Brush Satin



6 – Indicator

Material:
Diecast Zinc
Finish:
Brush Satin



7 – Bumper

Material:
Brass
Finish:
Brush Satin

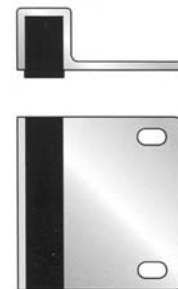

Complete Set

DESCRIPTION	CODE
Satin Stainless Steel	559000

▲ SERIES 18

C.P. BRASS and S.C.P. BRASS

1 – Spring Hinge

Material:
Extruded Brass and
Pressed Brass
Finish:
C.P. and S.C.P.

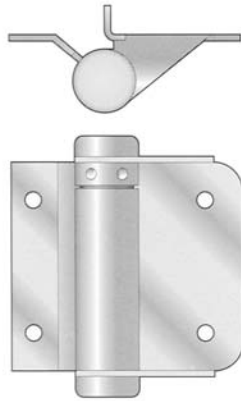

2 – Coat Hook

Material:
Diecast Zinc
Finish:
C.P. and S.C.P.



3 – Turnbolt

Material:
Diecast Zinc
Finish:
C.P. and S.C.P.



4 – Staple

Material:
Brass
Finish:
C.P. and S.C.P.

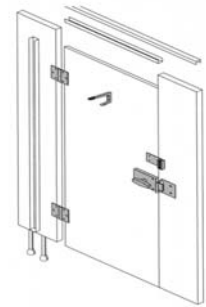
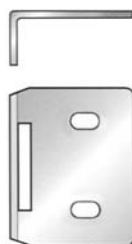

5 – Dress Plate

Material:
304 Grade SS
Finish:
Brushed Satin



6 – Indicator

Material:
Diecast Zinc
Finish:
C.P. and S.C.P.



7 – Bumper

Material:
Extruded Brass
Finish:
C.P. and S.C.P.

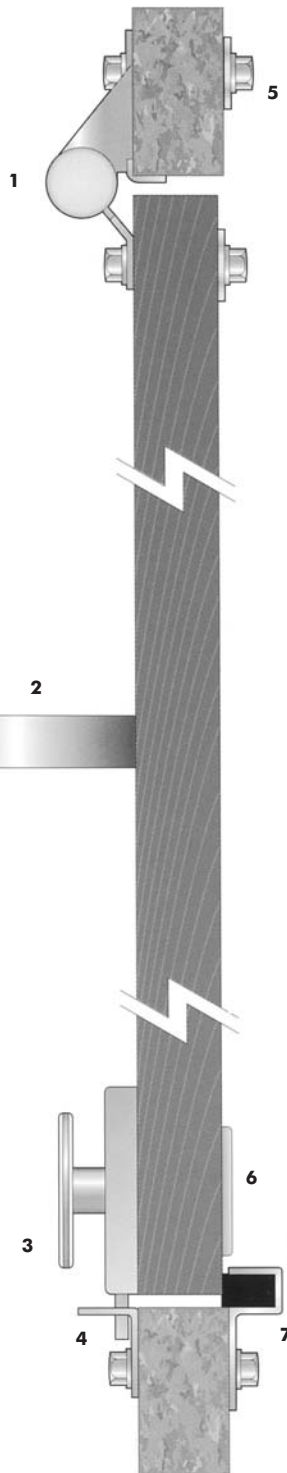
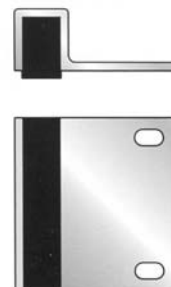

Complete Sets

DESCRIPTION	CODE
C.P. BRASS	559001
S.C.P. BRASS	559002

▲ SERIES 37
GRAVITY DROP HINGE

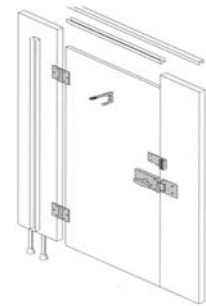

Example: Left Hand Hinged.

1 – Gravity Drop Hinge

Material:
Die Cast Zinc with
Nylon Cams
Finish:
S.C.P.

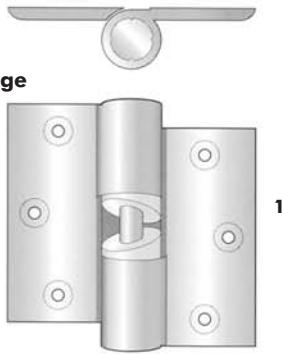

2 – Coat Hook

Material:
Diecast Zinc
Finish:
S.C.P.

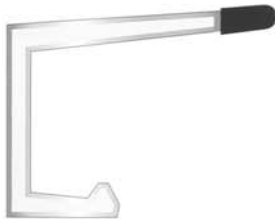

3 – Turnbolt

Material:
Diecast Zinc
Finish:
S.C.P.



4 – Staple

Material:
Extruded Brass
Finish:
S.C.P.

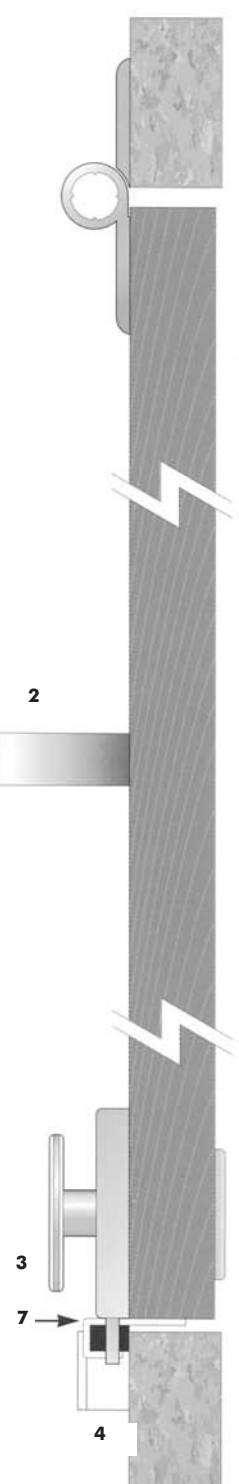

6 – Indicator

Material:
Diecast Zinc
Finish:
S.C.P.



7 – Bumper

Material:
Extruded Brass
Finish:
S.C.P.

Complete Set

DESCRIPTION	SIZE	CODE
Left Hand	Gravity Drop Hinge	559003
Right Hand	Gravity Drop Hinge	5590035

▲ CHANNELLING

To suit 18mm PARTITIONING

Aluminium Extrusion – Clear Anodised



AL 48



AL 49

DESCRIPTION	SIZE	CODE
AL 48	1800mm	559010
AL 48	2100mm	559011
AL 48	3000mm	559012
AL 49	2000mm	559015

▲ PEDESTALS

Material: Grade 304 SS

S.C.P.

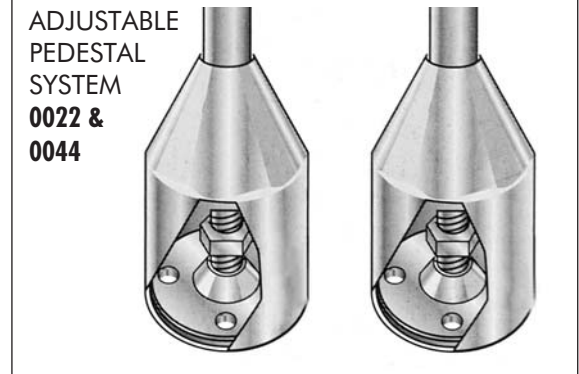
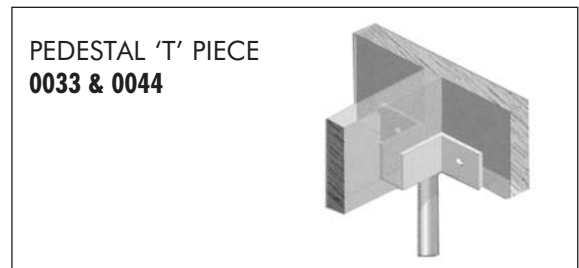
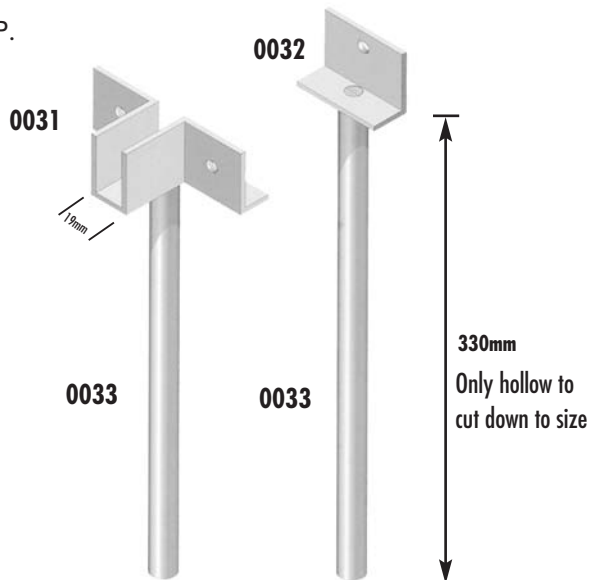

Material: 304 Grade SS

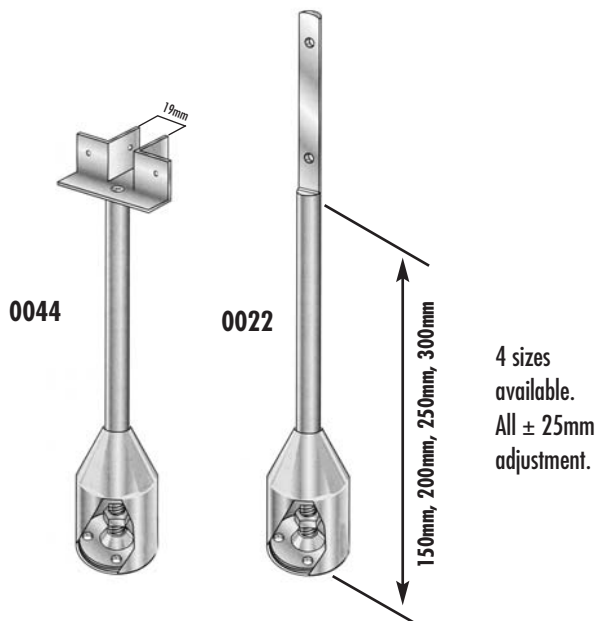

SCP BRASS		
DESCRIPTION	SIZE	CODE
0031		559032
0032		559033
0033	330mm	559025

304 GRADE SS		
DESCRIPTION	SIZE	CODE
0044		559040
0022		559041